

CUSTOM KITCHEN CABINET & REFACING

98 Monarch Drive
Amherst, New York 14226
Phone (716) 832-9737
Fax (716) 832-9294
Orders (888) 40 REFACE toll free

How to Order and Measure

Order *exact* overall door sizes. Please do not order by opening sizes

- ◆ Select **WOOD TYPE**.
- ◆ Select **DOOR DESIGN**.
- ◆ Select **EDGE PROFILE**. Doors or drawer fronts ordered without edge profile will be shipped rough-cut on edges and 1/8" larger than sizes ordered. All four sides will be edged the same unless otherwise indicated. For doors or drawer fronts ordered with more than one edge profile, add 50 cents per square foot.
- ◆ Indicate **APPLIED MOLDING** if desired by adding W/M to Design Number.
- ◆ Determine **DOOR AND DRAWER FRONT SIZES**. Order by giving exact overall door or drawer front sizes. Below are recommended dimension allowances. A different amount may be needed where a special fit is required.
 - For edge profiles 101, 121, or 122, add 1/2" to opening height and width.
 - For all other edge profiles, add 1" to the height and width.
- ◆ Check for **MINIMUM SIZE PROBLEMS**. Some doors over 26" in width and/or 46" in height will have double panels.
- ◆ **MAXIMUM GUARANTEED SIZES**: Doors 23" wide and/or 46" high; Drawer Fronts 30" wide and/or 12" high.

How to Price

- ◆ **DETERMINE SQUARE FOOTAGE** by multiplying exact door/drawer front width times the height and dividing by 144 (round off to the nearest 100th), i.e. $12\frac{1}{2} \times 27\frac{3}{4}$ Door = $(12.5 \times 27.75) / 144 = 2.41$ sq. ft.
- ◆ **MULTIPLY SQUARE FEET BY SQUARE FOOT PRICE**; i.e. Red Oak # 800 2.41 sq. ft. x \$8.20 = \$19.76

FRAME-ONLY DOORS:

USE 9" FOR WIDTH X ACTUAL HEIGHT REGARDLESS OF ACTUAL WIDTH TO FIGURE SQUARE FOOTAGE.

Standard Door Specifications

TOLERANCES

Width: + or - 1/16"
Height: + or - 1/16"
Thickness: + or - 1/32"

FRAMELESS & FULL
OVERLAY APPLICATIONS
See page 17

SANDING

Face: 220x Panel Profile: 180x
Back: 180x Edge profile: 180x

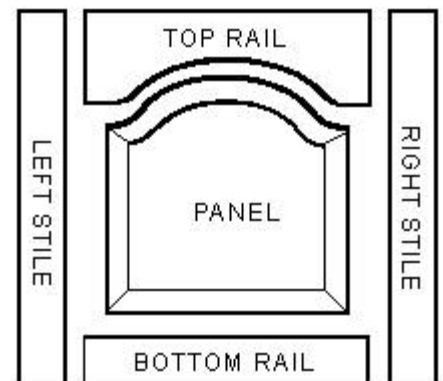
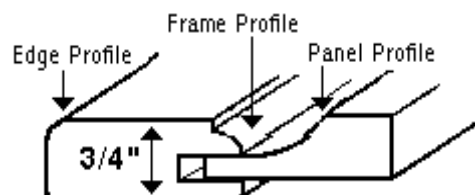
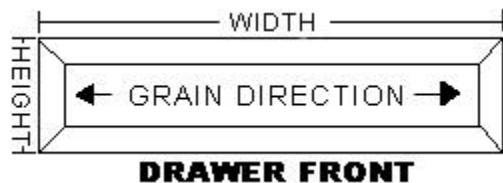

WITH RED
OAK PULLS

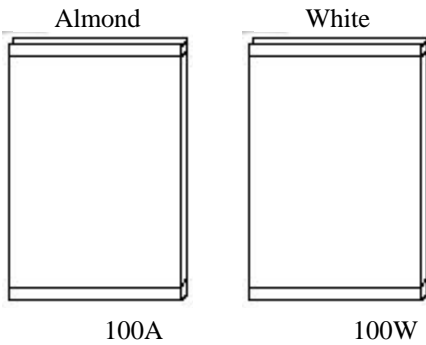

100
SERIES
LAMINATE
DOORS

WITH MATCHING PVC EDGE
BANDING ON ALL FOUR EDGES

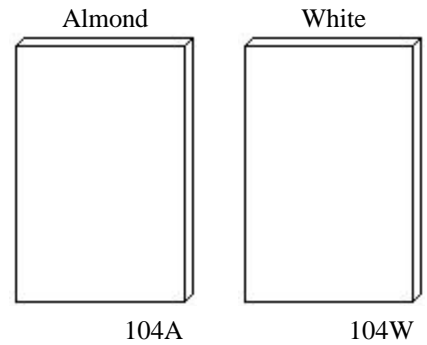

ALL PRICES ARE PER
SQUARE FOOT

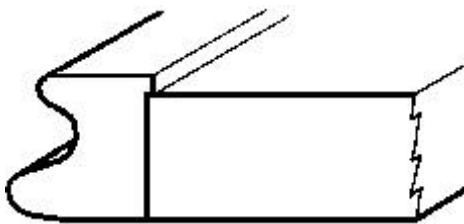

DOORS

MATCHING DRAWER FRONTS

DESIGN NUMBER	*RED OAK WOOD PULLS	EDGE BANDED 4 SIDES	MINIMUM SIZE WIDTH X HEIGHT
100 A or W	\$ 7.20	N/A	4 1/2 X 12
104 A or W	N/A	\$ 5.80	12 X 12

DESIGN NUMBER	*RED OAK WOOD PULLS	EDGE BANDED 4 SIDES	MINIMUM SIZE WIDTH X HEIGHT
10F A or W	\$ 12.80	N/A	4 1/2 X 3 1/2
14F A or W	N/A	\$ 11.20	4 1/2 X 3 1/2

Almond
or
White

Laminate Doors are constructed using 5/8" high grade particle board core with Thermofused Melamine laminated to face and back. Edge Banded with matching color.

NO EXTRA CHARGE FOR PRE-FINISHED RED OAK PULLS.
Available finishes: **Harvest, Royal, and Frost**

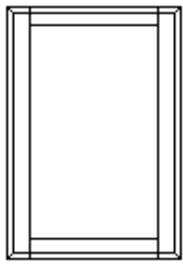

200

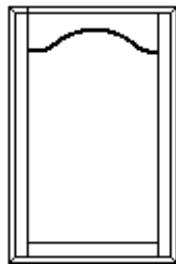

201

200

SERIES

PLYWOOD

PANEL DOORS

2 1/4" WOOD FRAMES

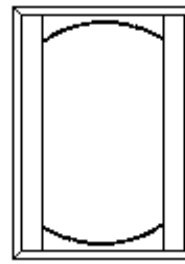

203

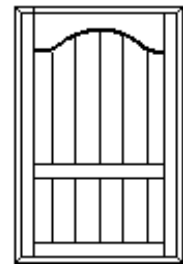

2211VG

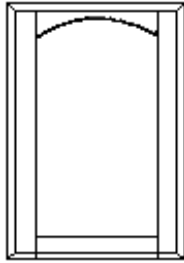

216

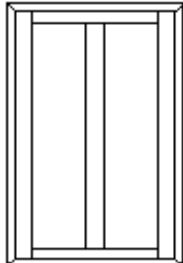

220

ALL PRICES ARE PER SQUARE FOOT

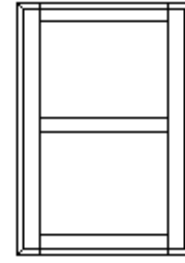

244

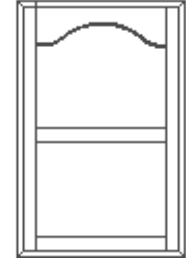

291

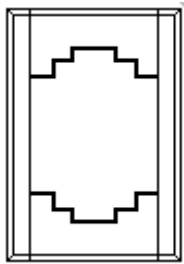

231

EDGE PROFILES

NO CHARGE EDGES
See page 17

ADD PER SQUARE FOOT

- All "E" Edges....\$.50
- 124 edge.....\$ 3.00
- More than 1 edge on the same door.....\$.50

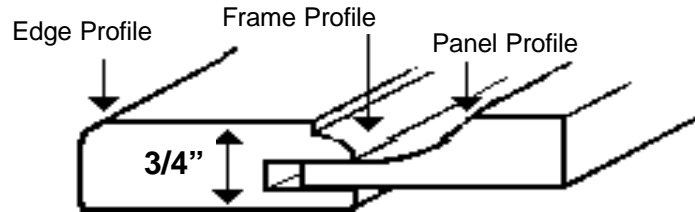

SELECT WOODS

Deduct \$.30 sq. ft. for MDF Panel. (Medium Density Fiberboard)
\$ 1.50 sq. ft. for STANDARD Cherry or White Oak

DESIGN NUMBER	PLYWOOD PANEL RED OAK / LAUAN or ALDER / MAPLE	PLYWOOD ASH	PLYWOOD MAPLE	PLYWOOD PAINT GRADE Specify Panel, MDF or Maple	SELECT PLYWOOD RED OAK	SELECT PLYWOOD ASH	SELECT PLYWOOD MAPLE	K. PINE HICKORY SELECT WHITE OAK SELECT CHERRY	PAINT GRADE MAPLE Specify Panel, MDF or Maple	MINIMUM SIZE Width x Height
					Same wood type on face and back. A2 grade plywood					
200	10.40	10.80	12.20	9.60	10.80	11.20	13.80	16.70	10.30	6 1/2 X 6 1/2
*200F 5 Piece DF	21.40	21.80	23.20	20.60	21.80	22.20	24.80	27.70	21.30	6 1/2 X 5 3/4
*200FS Rails 1 1/2"	22.65	23.05	24.45	21.85	23.05	23.45	26.05	28.95	22.55	6 1/2 X 4 1/2
200SS 1 Stile 3"	12.90	13.30	14.70	12.10	13.30	13.70	16.30	19.20	12.80	6 1/2 X 7 1/4
201	11.60	12.20	13.60	10.80	12.30	12.70	15.40	18.10	11.60	7 X 8
203	12.80	13.30	14.60	11.80	13.30	13.90	16.60	19.30	12.90	7 X 10
211VG	17.60	17.90	19.40	16.60	18.30	18.70	22.00	23.70	17.90	7 X 12 1/2
216	11.60	12.20	13.60	10.80	12.30	12.70	15.40	18.10	11.60	7 X 8
220	13.60	14.00	15.50	12.70	14.20	14.60	17.50	20.30	13.60	11 1/2 X 6 1/2
231 "D" IFP ONLY	18.50	N/A	20.50	N/A	19.30	N/A	23.20	27.00	N/A	10 X 10
244	12.80	13.30	14.60	11.80	13.30	13.90	16.60	19.10	12.90	6 1/2 X 12 1/2
291 201/200	13.60	14.00	15.50	12.70	14.20	14.60	17.50	20.30	13.60	7 X 12 1/2

Add for Finishing: BURGANDY and CHERYSTONE \$10.00 per sq ft... FROST, SANIBEL, and WHEAT \$7.50 per sq ft...

HARVEST, ROYAL, and NATURAL \$6.50 per sq ft.

Available Finishes	Harvest Royal (oak only)	Harvest Royal	Cherystone	Harvest Royal Natural Frost	Natural Frost	Harvest Royal Natural Frost Wheat	See # 300 series for available finishes
--------------------	--------------------------	---------------	------------	-----------------------------	---------------	-----------------------------------	---

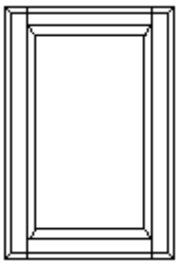

300

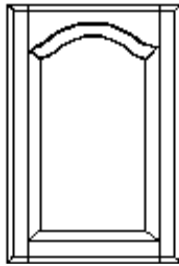

301

300
 SERIES
**RAISED
 PANEL
 DOORS**
 2 1/4" WOOD
 FRAMES

ALL PRICES ARE PER SQUARE FOOT

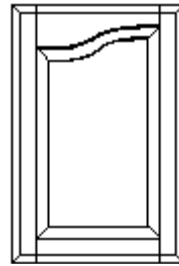

302

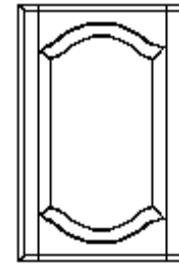

303

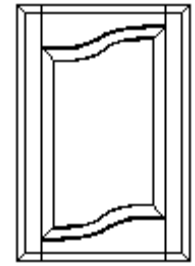

304

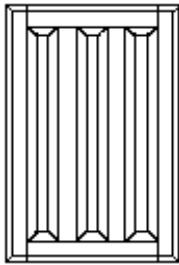

305

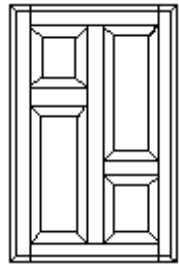

306

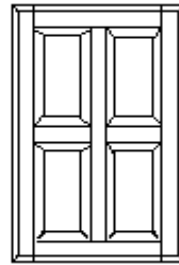

307

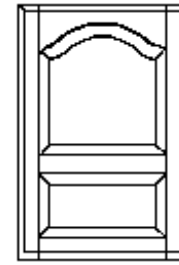

311

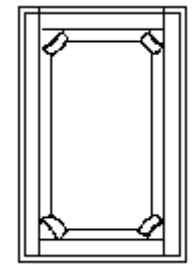

312

DESIGN NUMBER RED OAK ASH BIRCH or MAPLE CHERRY KNOTTY PINE WHITE PINE HICKORY WHITE OAK **MINIMUM SIZE WIDTH X HEIGHT**

300	17.20	16.70	21.30	22.80	14.00	14.20	17.50	17.10	7 X 7
*300F 5 PIECE D/F	28.20	27.70	32.30	33.80	25.00	25.20	28.50	28.10	7 X 7
*300FS Rails 1 1/2"	29.45	28.95	33.55	35.05	26.25	26.45	29.75	29.35	7 X 5 1/2
300SS 1-Stile 3"	19.70	19.20	23.80	25.30	16.50	16.70	20.00	19.60	7 3/4 X 7
301	19.00	18.40	23.30	24.60	15.80	16.00	19.20	18.80	9 X 10
302	19.00	18.40	23.30	24.60	15.80	16.00	19.20	18.80	9 X 10
303	19.90	19.40	24.30	25.70	16.80	17.00	20.20	19.80	9 X 12 1/2
304	21.10	20.50	25.40	26.80	17.80	18.00	21.20	20.90	9 X 12 1/2
305	20.60	19.90	24.80	26.30	17.40	17.60	20.80	20.50	15 1/2 X 7
306	22.70	21.90	27.00	28.50	19.30	19.50	32.80	22.30	11 1/2 X 14 1/2
307	22.70	21.90	27.00	28.50	19.30	19.50	22.80	22.30	11 1/2 X 11 1/2
311	21.80	21.20	26.20	27.60	18.50	18.70	21.90	21.60	9 X 14 1/2
312	22.00	21.40	26.40	27.80	18.70	18.90	22.10	21.80	11 1/2 X 11 1/2
314	19.90	19.40	24.20	25.70	16.80	17.00	20.20	19.80	10 X 11
315	23.60	23.00	27.90	29.50	20.40	20.60	23.70	23.40	11 1/2 X 12 1/2
316	19.00	18.40	23.30	24.60	15.80	16.00	19.20	18.80	9 X 9 1/2
317	19.90	19.40	24.20	25.70	16.80	17.00	20.20	19.80	9 X 10 1/2
318	21.80	21.20	26.20	27.60	18.50	18.70	21.90	21.60	9 X 14 1/2
320	19.40	18.80	23.70	25.00	16.20	16.40	19.60	19.30	11 1/2 X 7
323	19.20	18.60	23.50	24.80	16.00	16.20	19.40	19.10	9 X 10
324	20.30	19.70	24.60	26.10	17.10	17.40	20.60	20.20	7 X 14
344	20.30	19.70	24.60	26.10	17.10	17.40	20.60	20.20	7 X 11 1/2
370 Slab Not Guaranteed	19.00	18.40	23.50	25.00	15.40	15.70	19.20	18.80	4 X 4
375	25.20	24.50	29.70	31.20	N/A	N/A	N/A	24.90	7 1/2 X 8
*375F Drawer Front	37.60	36.40	42.40	44.10	N/A	N/A	N/A	36.80	7 1/2 X 4
391 (301/300)	21.30	20.70	25.70	27.00	18.00	18.20	21.40	21.10	9 X 14 1/2

Add for Finishing: BURGANDY and CHERRYSTONE \$10.00 per sq ft... FROST, SANIBEL, and WHEAT \$7.50 per sq ft...
 HARVEST, ROYAL, and NATURAL \$6.50 per sq ft.

Available Finishes	Harvest		Royal	Harvest	Harvest	Royal	
	Royal		Café	Natural	Natural	Natural	
	Nordic		Sanibel	Royal			
	Caramel		Cherrystone	Natural			
	Chestnut		Burgandy	Frost			

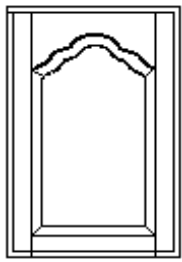

314

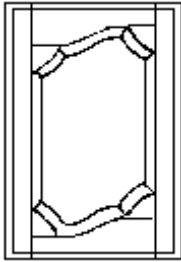

315

300

SERIES
RAISED
PANEL
DOORS
2 1/4" WOOD
FRAMES

ALL PRICES ARE PER SQUARE FOOT

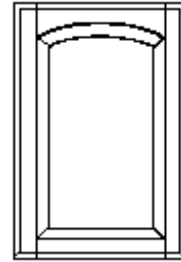

316

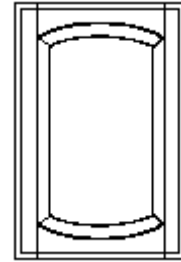

317

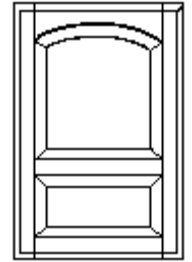

318

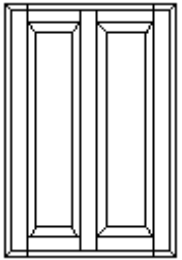

320

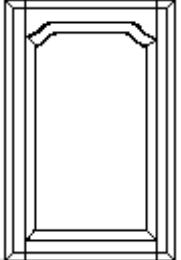

323

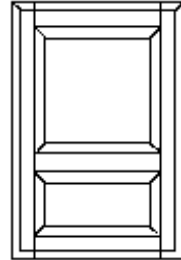

324

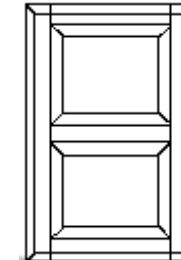

344

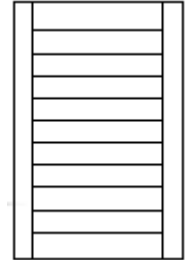

375

DESIGN NUMBER	MAHOGANY or WALNUT	PAINT GRADE MAPLE	PAINT GRADE or POPLAR	PG FRAME MDF PANEL	SELECT RED OAK	SELECT ASH	SELECT MAPLE	SELECT CHERRY	SELECT WHITE OAK	MINIMUM SIZE WIDTH X HEIGHT
300	30.10	16.00	13.40	11.10	19.50	19.00	25.20	25.90	19.40	7 X 7
*300F 5 PIECE D/F	41.10	27.00	24.40	22.10	30.50	30.00	36.20	36.90	30.40	7 X 7
*300FS Rails 1 1/2"	42.35	28.25	25.65	23.35	31.75	31.25	37.45	38.15	31.65	7 X 5 1/2
300SS 1-Stile 3"	32.60	18.50	15.90	13.60	22.00	21.50	27.70	28.40	21.90	7 3/4 X 7
301	31.90	17.80	15.10	13.00	21.60	20.90	27.50	27.90	21.30	9 X 10
302	31.90	17.80	15.10	13.00	21.60	20.90	27.50	27.90	21.30	9 X 10
303	32.90	18.70	16.10	13.90	22.70	22.00	28.70	29.10	22.50	9 X 12 1/2
304	33.90	19.70	17.10	14.90	23.90	23.30	30.00	30.40	23.70	9 X 12 1/2
305	33.50	19.30	16.70	14.40	23.40	22.70	29.40	29.80	23.30	15 1/2 X 7
306	35.40	21.30	18.60	16.40	25.70	24.80	32.00	32.30	25.40	11 1/2 X 14 1/2
307	35.40	21.30	18.60	16.40	25.70	24.80	32.00	32.30	25.40	11 1/2 X 11 1/2
311	34.60	20.60	17.90	15.70	24.70	24.10	31.10	31.40	24.50	9 X 14 1/2
312	34.80	20.80	18.10	15.90	25.00	24.30	31.10	31.60	24.70	11 1/2 X 11 1/2
314	32.90	18.70	16.10	13.90	22.70	22.00	28.70	29.10	22.50	10 X 11
315	36.50	22.20	19.60	17.50	26.80	26.10	33.10	33.50	26.50	11 1/2 X 12 1/2
316	31.90	17.80	15.10	13.00	21.60	20.90	27.50	27.90	21.30	9 X 9 1/2
317	32.90	18.70	16.10	13.90	22.70	22.00	28.70	29.10	22.50	9 X 10 1/2
318	34.60	20.60	17.90	15.70	24.70	24.10	31.10	31.40	24.50	9 X 14 1/2
320	32.30	18.20	15.50	13.40	22.00	21.30	28.10	28.50	21.90	11 1/2 X 7
323	32.10	18.00	15.30	13.20	21.80	21.10	27.80	28.20	21.70	9 X 10
324	33.20	19.10	16.40	14.20	23.00	22.40	29.20	29.60	22.90	7 X 14
344	33.20	19.10	16.40	14.20	23.00	22.40	29.20	29.60	22.90	7 X 11 1/2
370 Slab Not Guaranteed	33.10	17.60	14.80	N/A	20.90	20.60	26.10	25.90	21.20	4 X 4
375	N/A	23.80	21.20	N/A	28.70	27.80	35.20	35.40	28.30	7 1/2 X 8
*375F Drawer Front	N/A	35.50	33.00	N/A	40.10	39.30	46.70	46.90	39.70	7 1/2 X 4
391 (301/300)	34.10	19.90	17.40	15.10	24.20	23.50	30.40	30.70	23.90	9 X 14 1/2

Add for Finishing: BURGANDY and CHERRYSTONE \$10.00 per sq ft... FROST, SANIBEL, and WHEAT \$7.50 per sq ft...

HARVEST, ROYAL, and NATURAL \$6.50 per sq ft.

Available Finishes	Natural				Harvest			Harvest	
					Royal		Royal	Royal	
					Natural		Natural	Natural	Natural
					Frost		Frost	Frost	Frost
					Nordic		Wheat		
				Caramel		Cherrystone			
				Chestnut			Burgandy		

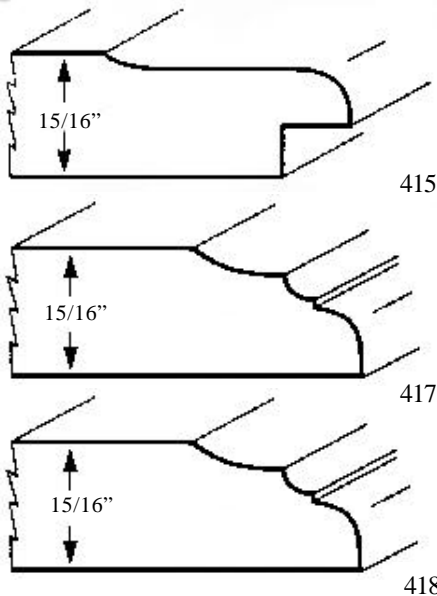

400

SERIES
DRAWER
FRONTS

Grain runs Left to Right

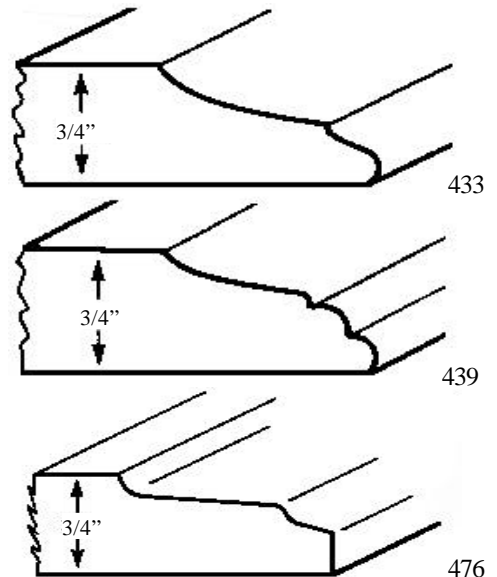

**ALL PRICES ARE PER
SQUARE FOOT**

DESIGN NUMBER	*400 (glued up)	*444 (1 Solid piece) MAXIMUM 6"H	433, 439, 476	410	*414	415, 417, 418	* 400 and 444 drawer fronts are simply 3/4" thick slabs with the same edge on them as on the doors.		
	3/4" THICK			15/16" THICK					
RED OAK (or ALDER)	\$15.30	\$16.70	\$16.70	\$18.00	\$19.60	\$19.60	HARVEST ROYAL	NORDIC CARAMEL	CHESTNUT (OAK ONLY)
ASH	\$14.80	NA	\$16.20	\$17.40	NA	\$19.10	NONE		
MAPLE	\$19.60	\$21.10	\$21.10	\$23.10	\$24.80	\$24.80	ROYAL CAFÉ	SANIBEL	CHERRYSTONE
PAINT GRADE	\$12.20	NA	\$14.20	\$14.40	NA	\$16.70	NONE		
CHERRY	\$21.20	NA	\$22.70	\$24.90	NA	\$26.70	HARVEST ROYAL	NATURAL FROST	BURGANDY
KNOTTY PINE	\$13.10	NA	\$14.40	NA	NA	NA	HARVEST	NATURAL	
HICKORY	\$15.50	NA	\$16.70	NA	NA	NA	ROYAL	NATURAL	
WHITE OAK	\$16.30	NA	\$17.80	NA	NA	NA	NATURAL		
MAHOGONY or WALNUT	\$26.50	NA	\$28.60	NA	NA	NA	NATURAL		
PAINT GRADE	\$13.50	NA	\$16.00	NA	NA	NA	NONE		
WHITE PINE	\$13.50	NA	\$15.20	NA	NA	NA	HARVEST	NATURAL	
POPLAR	\$13.10	NA	\$14.40	NA	NA	NA	NONE		
MDF	ORDER 7DF WITHOUT WHITE BACK			NA	NA	NA	NONE		
SELECT WOODS							AVAILABLE COLORS		
SELECT RED OAK	17.40	19.00	19.00	20.50	22.40	22.40	HARVEST ROYAL	NATURAL FROST	NORDIC CARAMEL CHESTNUT
SELECT ASH	16.80	NA	18.30	19.80	NA	21.50			
SELECT MAPLE	22.30	23.90	23.90	26.20	28.10	28.10	ROYAL CAFÉ	NATURAL FROST	CHERRYSTONE WHEAT
SELECT CHERRY	24.10	NA	25.80	28.40	NA	30.40	HARVEST ROYAL	NATURAL FROST	BURGANDY
SELECT WHITE OAK	18.50	NA	20.20	21.80	NA	23.80	HARVEST	NATURAL FROST	
MINIMUM SIZE Width x Height	6 X 3 1/2	6 X 3 1/2 <small>*(MAXIMUM 6" H on 444)</small>	6 X 5	6 X 5	6 X 5	6 X 5	SOLID DRAWER FRONTS		
ORDER # 400 DRAWER FRONT AND SPECIFY ANY OPTIONAL EDGE PROFILE SHOWN ON EDGE PROFILE PAGE FOR A RAISED PANEL LOOK, ORDER # 439, 433, 476, 415, 417, or 418									

SPECIFICATIONS

500

SERIES

EDGE PROFILES FOR:

500 and 500F	
	ADD
119	N/C
115	N/C
115E	\$.50 Sq. Ft.
112	\$ 1.00 Sq. Ft.
112E	\$ 1.50 Sq. Ft.
132	\$ 1.00 Sq. Ft.
132E	\$ 1.50 Sq. Ft.

504 and 504F	
	ADD
115	N/C
115E	\$.50 Sq. Ft.
112	\$ 1.00 Sq. Ft.
112E	\$ 1.50 Sq. Ft.
132	\$ 1.00 Sq. Ft.
132E	\$ 1.50 Sq. Ft.

530 and 530F	
	ADD
119	\$1.00 Sq. Ft.
115	N/C
115E	\$.50 Sq. Ft.
112	N/C
112E	\$.50 Sq. Ft.
132	\$ 1.00 Sq. Ft.
132E	\$ 1.50 Sq. Ft.

540VG and 540VGF	
	ADD
119	\$1.00 Sq. Ft.
115	N/C
115E	\$.50 Sq. Ft.
112	N/C
112E	\$.50 Sq. Ft.
132	\$ 1.00 Sq. Ft.
132E	\$ 1.50 Sq. Ft.

550 and 550F	
	ADD
119	\$ 1.00 Sq. Ft.
115	N/C
115E	\$.50 Sq. Ft.
112	\$ 1.00 Sq. Ft.
112E	\$ 1.50 Sq. Ft.
132	N/C
132E	\$.50 Sq. Ft.

560 and 560F	
	ADD
119	\$ 1.00 Sq. Ft.
115	N/C
115E	\$.50 Sq. Ft.
112	\$ 1.00 Sq. Ft.
112E	\$ 1.50 Sq. Ft.
132	N/C
132E	\$.50 Sq. Ft.

DOORS

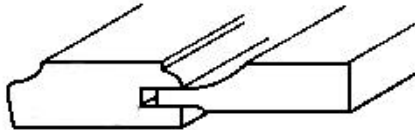

500 - Shown with 119 edge

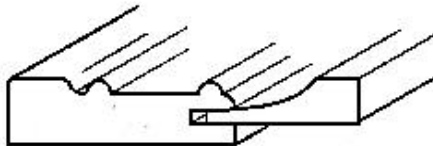

504 - Shown with 115 edge

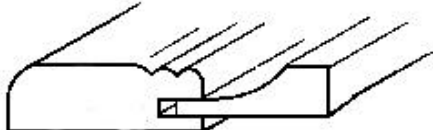

530 - Shown with 112 edge

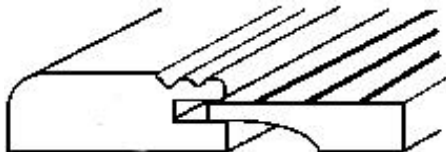

540VG - Shown with 112 edge

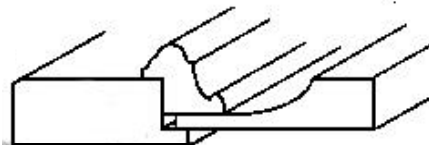

550M - Shown with 115 edge

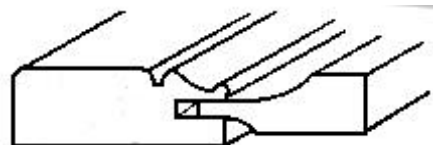

560 - Shown with 115 edge

MATCHING DRAWER FRONTS

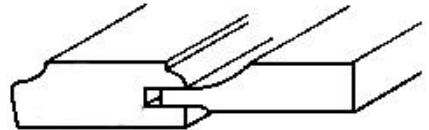

500F - Shown with 119 edge
*HEIGHTS LESS THAN 6 1/2" WILL
HAVE "R" PANEL CUT.*



504F - Shown with 115 edge
*HEIGHTS LESS THAN 5 1/2" WILL
HAVE "R" PANEL CUT.*

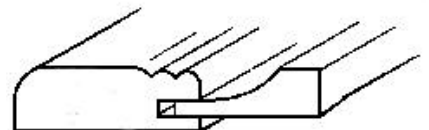

530F - Shown with 112 edge
*HEIGHTS LESS THAN 7" WILL
HAVE "R" PANEL CUT.*

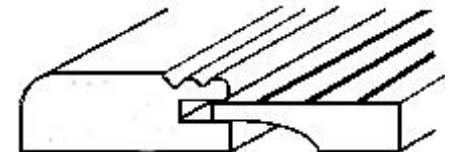

540VGF - Shown with 112 edge

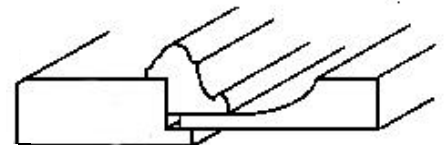

550MF - Shown with 115 edge

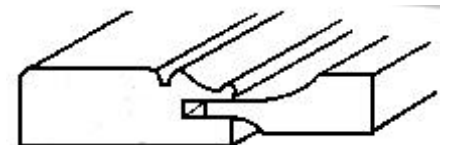

560F - Shown with 115 edge

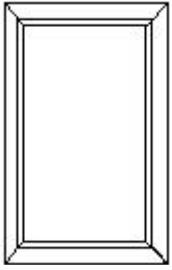

500

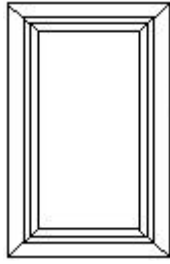

530

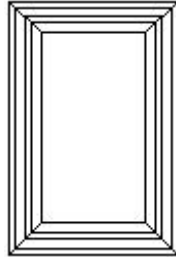

550M

500
 SERIES
**RAISED
 PANEL
 MITERED
 DOORS**
 2 1/4" WOOD FRAMES

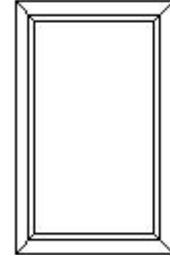

560

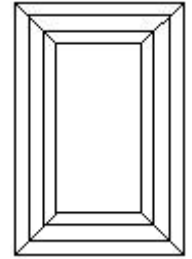

504

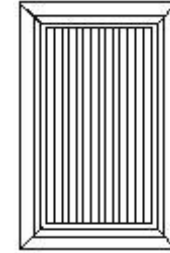

540VG

ALL PRICES ARE PER
 SQUARE FOOT

DESIGN NUMBER	RED OAK	ASH	MAPLE	CHERRY	Paint Grade MAPLE	Paint Grade MAPLE MDF panel	SELECT RED OAK	SELECT ASH	SELECT MAPLE	SELECT CHERRY or HICKORY	MINIMUM SIZE Width x Height
500 2 1/8" FRAME	\$16.50	\$15.90	\$20.60	\$21.40	\$13.90	\$13.90	\$18.70	\$16.50	\$23.40	\$20.30	7 X 7
*500F 2 1/8" FRAME	\$27.50	\$26.90	\$31.60	\$32.40	\$24.90	\$24.90	\$29.70	\$27.50	\$34.40	\$31.30	7 X 5 1/2
504 2 9/16" FRAME	\$17.70	\$16.90	\$21.70	\$22.50	\$14.90	\$14.90	\$20.10	\$17.50	\$24.60	\$21.30	8 1/2 X 8 1/2
*504F 1 1/2" FRAME	\$28.70	\$27.90	\$32.70	\$33.50	\$25.90	\$25.90	\$31.10	\$28.50	\$35.60	\$32.30	6 1/2 X 4 1/2
530 2 1/8" FRAME	\$16.80	\$16.10	\$20.80	\$21.60	\$14.10	\$14.10	\$19.10	\$16.70	\$23.60	\$20.50	7 X 7
*530F 2 1/8" FRAME	\$27.80	\$27.10	\$31.80	\$32.60	\$25.10	\$25.10	\$30.10	\$27.70	\$34.60	\$31.50	7 X 5 1/2
540VG 2 1/8" FRAME	\$21.80	\$21.10	\$26.00	\$26.90	\$18.90	\$18.90	\$24.70	\$21.70	\$29.50	\$25.50	7 X 7
*540VGF 2 1/4" FRAME	\$32.80	\$32.10	\$37.00	\$37.70	\$29.90	\$29.90	\$35.70	\$32.70	\$40.50	\$36.50	7 X 5 1/2
550M 2 5/16" FRAME	\$21.80	\$21.10	\$26.00	\$26.90	\$18.90	\$18.90	\$24.70	\$21.70	\$29.50	\$25.50	7 1/2 X 7 1/2
*550MF 2 5/16" FRAME	\$32.80	\$32.10	\$37.00	\$37.90	\$29.90	\$29.90	\$35.70	\$32.70	\$40.50	\$36.50	7 1/2 X 6 3/4
560 2 3/16" FRAME	\$16.80	\$16.10	\$20.80	\$21.60	\$14.10	\$14.10	\$19.10	\$16.70	\$23.60	\$20.50	7 X 7
*560F 2 3/16" FRAME	\$27.80	\$27.10	\$31.80	\$32.60	\$25.10	\$25.10	\$30.10	\$27.70	\$34.60	\$31.50	7 X 5

Add for Finishing: BURGANDY, CAFE and CHERRYSTONE \$10.00 per sq ft...

FROST, SANIBEL, and WHEAT \$7.50 per sq ft...

ALL OTHERS \$6.50 per sq ft.

Available Finishes	Harvest Royal Nordic Caramel Chestnut	NONE	Royal Café Sanibel Cherrystone	Harvest Royal Natural Burgandy Frost	NONE	NONE	Harvest Royal Natural Frost Nordic Caramel Chestnut	NONE	Royal Natural Frost Wheat Cherrystone Café	Harvest Royal Frost Burgandy <u>Hickory</u> Royal Natural
--------------------	---	------	---	--	------	------	---	------	---	---

- * Drawer Front - (Panel Grain Runs Left to Right)
- Doors over 46" High will have TWO Panels
- Maximum width of a single panel door is 26"

700 SERIES SPECIFICATIONS

I 3 or I 5 Profile
ORDER
 Radius Corner — 3 Pass
 Square Corner — 5 Pass

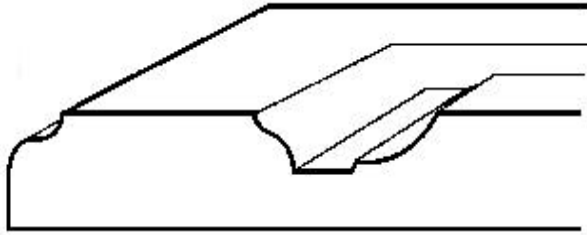

K 3 or K 5 Profile
ORDER
 Radius Corner — 3 Pass
 Square Corner — 5 Pass

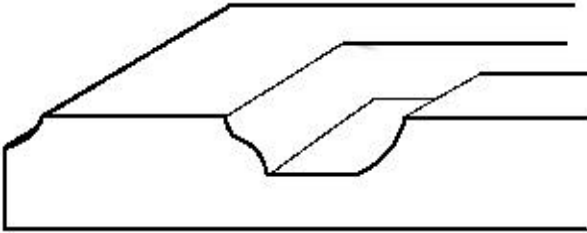

C 2 Profile
 Radius Corner — 2 Pass
 ONLY

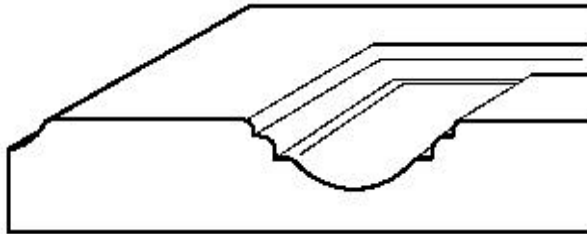

V 5 Profile
 Square Corner — 5 Pass
 ONLY

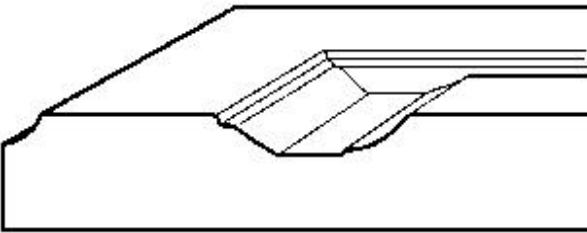

V 3 Profile
 Square Corner — 3 Pass
 ONLY

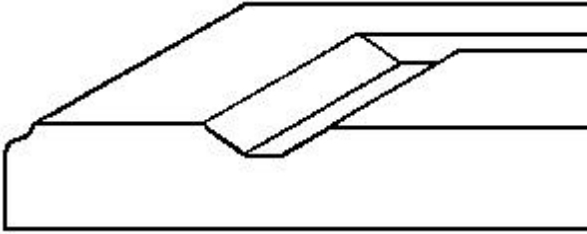

Q 6 Profile
 Square Corner — 6 Pass
 ONLY

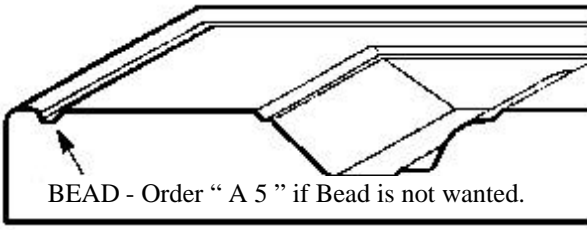

BEAD - Order "A 5" if Bead is not wanted.

EDGE PROFILES	
	ADD
113	N/C
115	N/C
141	N/C
102X	\$ 2.00 Sq. Ft.
105X	\$ 2.00 Sq. Ft.
112X	\$ 2.00 Sq. Ft.
132X	\$ 2.00 Sq. Ft.

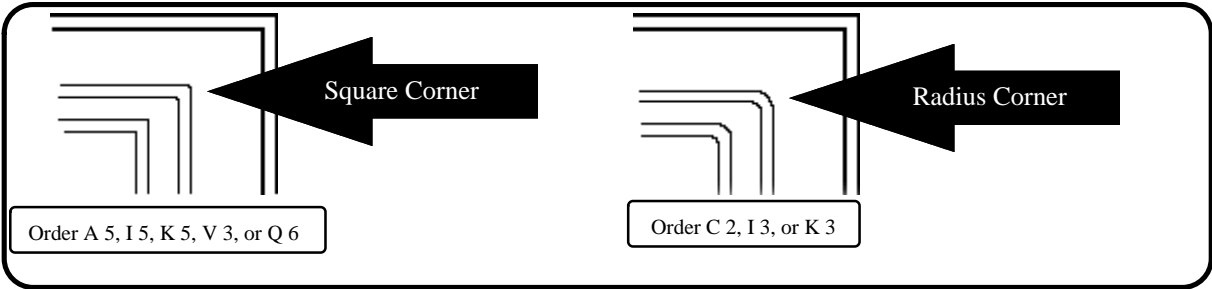



700

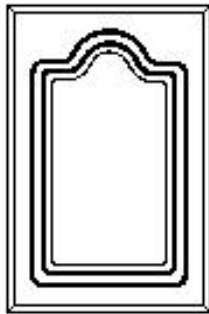

701

700

SERIES
MDF
and
RTF
DOORS

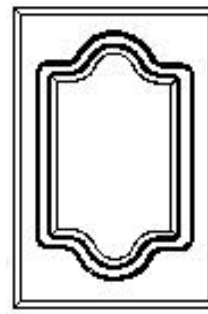

703

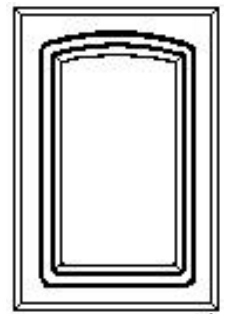

716

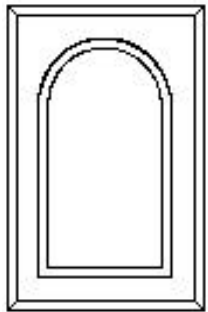

731

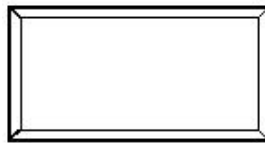

7DF

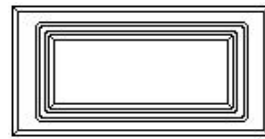

700FS

**ALL PRICES ARE
PER SQUARE FOOT**

RTF Doors: Rigid Thermo Foil is pressed using computer controlled heat and pressure over a one-piece high-quality M.D.F. panel with a low pressure Thermofused Melamine back, resulting in a high-quality K.C.M.A approved product. Scratch resistant white (or other color) Painted look without the problems and expense of painting.

MATTE WHITE or WOODGRAINS					
COLORS: Matte White (1W), Sanibel Maple (1MS), Pear (1P), Almond (1AL), Natural Maple (1MN), Matte Woodgrain White (1WW), Lite Oak (1LO), Antique White (1AT)					
DESIGN NUMBER	C 2 PASS	I, K, or V 3 PASS	A, I, K, or V 5 PASS	*Q6 6 PASS	MINIMUM SIZE WIDTH x HEIGHT
700	\$11.50	\$13.50	\$16.50	\$18.00	7 1/2 x 7 1/2
700FS MATCHING DRAWER FRONT, RAILS 1 1/4"	\$17.00	\$19.00	\$22.00	\$23.50	7 1/2 x 7 1/2
7DF FLAT SLAB DRAWER FRONT	\$11.50	1 PASS DRAWER FRONT (OUTSIDE EDGE PROFILE ONLY)			6 x 4
7FF FILLER PIECE, 115 EDGE ONLY	\$12.60	1 PASS FILLER PIECE (# 115 OUTSIDE EDGE PROFILE ONLY)			6 x 2 1/2
701	\$12.50	\$14.50	\$17.50	\$19.00	9 x 10
703	\$13.50	\$15.50	\$18.50	\$20.00	9 x 12 1/2
716	\$12.50	\$14.50	\$17.50	\$19.00	9 x 10
731	\$12.50	\$14.50	\$17.50	\$19.00	9 x 12 1/2
744 (2 PANELS HIGH)	\$13.50	\$15.50	\$18.50	\$20.00	9 x 15 1/2
791 (701/700)	\$14.50	\$16.50	\$19.50	\$21.00	9 x 15 1/2
796 (716/700)	\$15.50	\$17.50	\$20.50	\$22.00	9 x 15 1/2
FRAME ONLY DOOR USE 9" AS WIDTH FOR PRICING PURPOSES	\$45.00	\$45.00	\$50.00	\$51.50	12 x 12
MULLION DOOR	<i>Figure Frame-Only Price and Add \$8.50 per Lite</i>				

1 PASS DOOR WITH 112 EDGE AND OUTSIDE RADIUS CORNERS

77R2	\$12.60	1/2" RADIUS OUTSIDE CORNERS	ORDER 77R2F-112 or 77R4F-112 to have LEFT TO RIGHT GRAIN for Drawer Fronts (if Woodgrain)
77R4	\$12.60	1/4" RADIUS OUTSIDE CORNERS	

MDF-WITH RAW BACK: DEDUCT \$5.00 PER SQUARE FOOT FROM MATTE WHITE PRICE

MDF-WITH WITE MELAMINE: DEDUCT \$3.00 PER SQUARE FOOT FROM MATTE WHITE PRICE

RAW FOIL: (50" WIDE) \$6.30 PER LINEAL FOOT. (\$1.51 PER SQ FT.)

800 SERIES SPECIFICATIONS

EDGE PROFILES FOR:

800
107 ONLY
No Charge

802 and 802F
ADD
119 N/C
115 N/C
115E \$.50 Sq. Ft.
112 \$ 1.00 Sq. Ft.
112E \$ 1.50 Sq. Ft.
132 \$ 1.00 Sq. Ft.
132E \$ 1.50 Sq. Ft.

803 and 802F
ADD
119 N/C
115 N/C
115E \$.50 Sq. Ft.
112 \$ 1.00 Sq. Ft.
112E \$ 1.50 Sq. Ft.
132 \$ 1.00 Sq. Ft.
132E \$ 1.50 Sq. Ft.

830 and 830F
ADD
119 \$1.00 Sq. Ft.
115 N/C
115E \$.50 Sq. Ft.
112 N/C
112E \$.50 Sq. Ft.
132 \$ 1.00 Sq. Ft.
132E \$ 1.50 Sq. Ft.

850M and 850MF
ADD
119 \$1.00 Sq. Ft.
115 N/C
115E \$.50 Sq. Ft.
112 N/C
112E \$.50 Sq. Ft.
132 \$ 1.00 Sq. Ft.
132E \$ 1.50 Sq. Ft.

860 and 860F
ADD
119 \$ 1.00 Sq. Ft.
115 N/C
115E \$.50 Sq. Ft.
112 \$ 1.00 Sq. Ft.
112E \$ 1.50 Sq. Ft.
132 N/C
132E \$.50 Sq. Ft.

885 and 885F
ADD
119 \$ 1.00 Sq. Ft.
115 N/C
115E \$.50 Sq. Ft.
112 \$ 1.00 Sq. Ft.
112E \$ 1.50 Sq. Ft.
132 N/C
132E \$.50 Sq. Ft.

DOORS

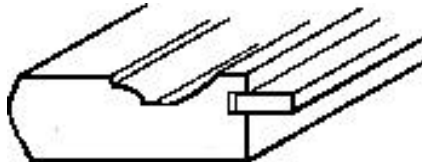

800 - Shown with 107 edge



802 - Shown with 119 edge



803 - Shown with 119 edge

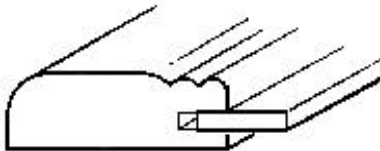

830 - Shown with 112 edge

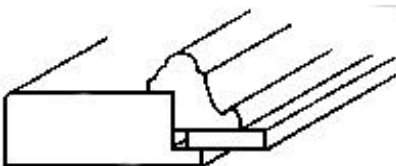

850M - Shown with 115 edge

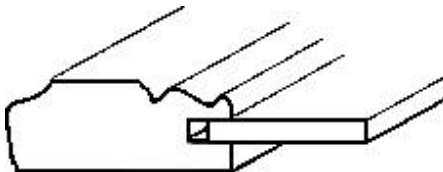

860 - Shown with 119 edge

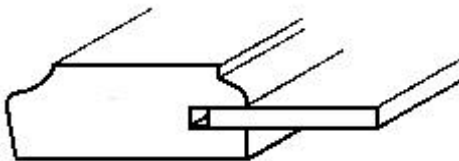

885 - Shown with 119 edge

MATCHING DRAWER FRONTS

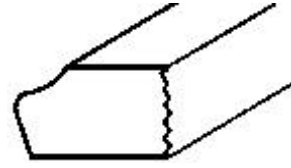

400 - shown with 119 edge

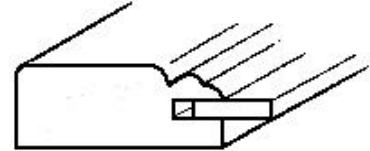

802F - Shown with 115 edge

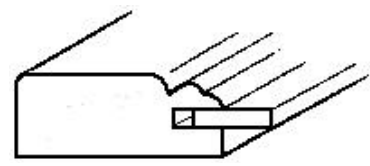

802F - Shown with 115 edge

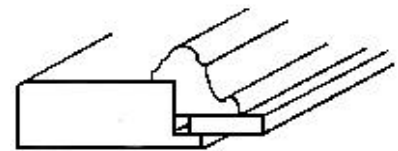

830F - Shown with 112 edge

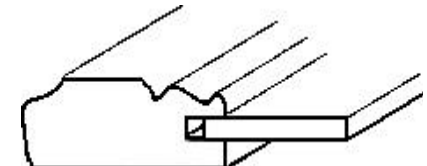

850MF - Shown with 115 edge

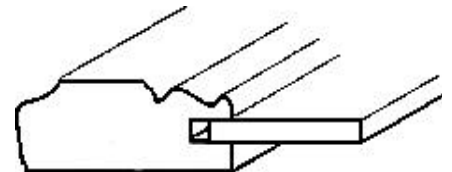

860F - Shown with 119 edge

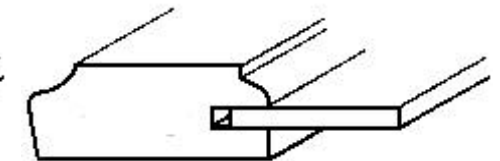

885F - Shown with 119 edge

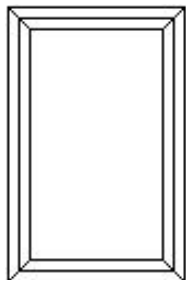

800

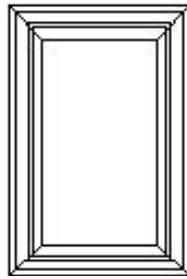

830

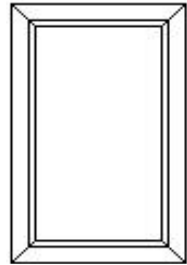

885

800
 SERIES
PLYWOOD
 PANEL
MITERED
DOORS
 2 1/4" WOOD
 FRAMES



850

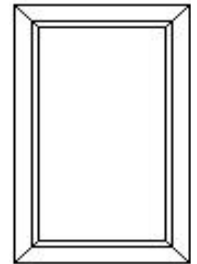

860

FRAME ONLY- use 500 series pricing except on #800, #802, and #803.

* Drawer Front - (Panel Grain runs Left to Right)

ALL PRICES ARE PER SQUARE FOOT

DESIGN NUMBER	PLYWOOD RED OAK front/ LAUAN back	PLYWOOD ASH	PLYWOOD MAPLE front/ BIRCH back	PLYWOOD PAINT GRADE	SELECT PLYWOOD RED OAK	SELECT PLYWOOD ASH	SELECT PLYWOOD MAPLE/ BIRCH	SELECT PLYWOOD CHERRY or HICKORY	MINIMUM SIZE Width x Height
800 2" Frame	9.00	9.20	10.20	8.10	9.70	9.90	11.30	NA	6 1/2 x 6 1/2
* 804F 1 1/2" Frame	23.80	24.50	26.10	23.40	25.50	26.20	28.90	29.30	6 1/2 x 4 1/2
830 2 1/8" Frame	9.70	9.90	10.80	8.60	10.30	10.50	11.90	15.70	6 1/2 x 6 1/2
* 830F 2 1/8" Frame	20.70	20.90	21.80	19.60	21.30	21.50	22.90	28.40	6 1/2 x 6 1/2
850M 2 5/16" Frame	16.70	16.70	18.00	15.60	17.90	17.90	19.90	26.70	7 x 7
* 850MF 2 5/16" Frame	27.70	27.70	29.00	26.60	28.90	28.90	30.90	39.30	7 x 6
860 2 3/16" Frame	9.70	9.90	10.80	8.60	10.30	10.50	11.90	15.70	6 1/2 x 6 1/2
* 860F 2 3/16" Frame	20.70	20.90	21.80	19.60	21.30	21.50	22.90	28.40	6 1/2 x 5
885 2 1/8" Frame	8.50	8.60	9.70	7.60	9.10	9.20	10.70	NA	6 1/2 x 6 1/2
* 885F 2 1/8" Frame	19.50	19.60	20.70	18.60	20.10	20.20	21.70	NA	6 1/2 x 6 1/2

**Add for Finishing: BURGANDY, CAFE and CHERRYSTONE \$10.00 per sq ft...
 FROST, SANIBEL, and WHEAT \$7.50 per sq ft...ALL OTHERS \$6.50 per sq ft.**

Available Finishes	Harvest Royal Nordic Caramel Chestnut	NONE	Royal Café Sanibel		Harvest Royal Natural Frost Nordic Caramel Chestnut	NONE	Royal Natural Frost Wheat Café Cherrystone	Same as 500 Series Colors
			Cherrystone					

Custom Kitchen

Cabinet Refacing
958 Oliver Street
North Tonawanda, NY 14120
Telephone: (716) 692-3535
Fax: (716) 695-2896

INSTALLING NEW DRAWERS AND SLIDES

1. Slide the left and right plastic end pieces (sockets) only slightly (about 1") onto the slides, so when they are installed into the cabinet box, you will have to push the slide further into the socket, and they will have enough pressure on them to stay in place before you actually screw in the socket at the back of the slide.
2. Starting with the RIGHT cabinet slide member, set the slide (the one with the roller capturing hooked top) in the right hand lower corner of the drawer opening and push it back further into the socket until it is flush with the front of the cabinet. Install a screw into the front face of the cabinet through the slide member to hold it generally in place. (Drywall screws work well for this because they are very sharp).
3. Mount the LEFT cabinet slide member the same manner.
4. After the two cabinet slide members are connected to the front of the cabinet face, insert the drawer box, ignoring the left slide for now. Move the RIGHT rear socket up and down, and left and right until the front of the drawer box lines up with the front of the cabinet.
5. While holding the right cabinet member slide at the rear plastic socket, mark a pencil line on a CORNER of the socket for reference, then remove the drawer box again. Line the RIGHT socket on the mark you made and screw it in with as many drywall screws as you want.
6. Reinsert the drawer box and move the loose LEFT side cabinet slide member into place at the back so the drawer lies evenly on all 4 rollers of the 4 slide members. You can move the Left member around to find the perfect fit. (not too high, not too low, not too loose and not too tight), and again mark a corner of the rear socket with a pencil line so you will know where to screw it in.
7. Remove the drawer box again and screw the LEFT cabinet slide member into place. Reinstall the drawer box and check that the drawer box lies flat on all the rollers and rolls freely. Check the front of the box again (with a ruler or the drawer front) to make sure that you have mounted it squarely with the front of the cabinet. If not, then move ONE or BOTH sockets around until the front of the drawer box is square to your satisfaction.
8. To mount the drawer front to the drawer box, we recommend that you use double faced tape (foam squares work well), so you can visually line up the drawer front and stick it to the drawer box before permanently mounting with screws. Once the drawer front is stuck to where you want it, open the drawer and drive three or four 1" drywall screws through the box and into the front to permanently affix the front to the drawer box.
9. NOTE: You can either countersink the screws for the handles into the drawer front using the screws that came with the handles BEFORE you permanently mount it, or you can drill through both the drawer front and the drawer box AFTER it is mounted. However, if you elect to mount the handles this way, you will have to buy longer bolts. You will need a "6-32" bolt aprox. 1 1/2" long or more to accomplish this.

STANDARD EDGE PROFILES

There is no extra charge when door or drawer front is edged the same on all four sides.
Add \$.50 per square foot for more than one edge on the same door or drawer front

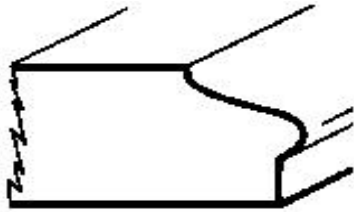

100

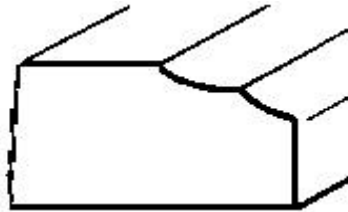

102

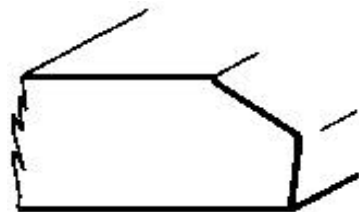

104

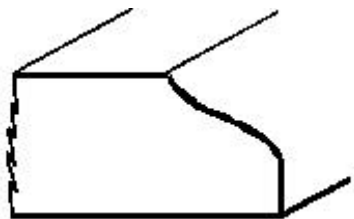

105



108

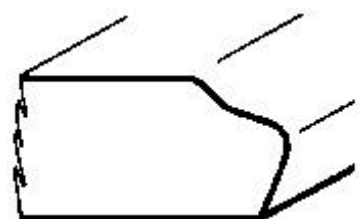

119

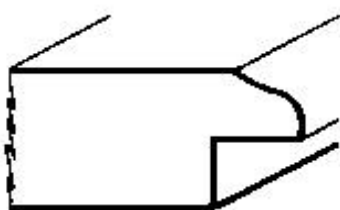

121

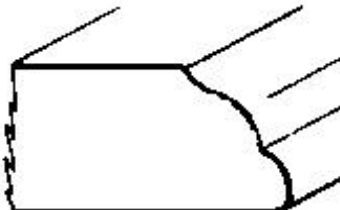

128

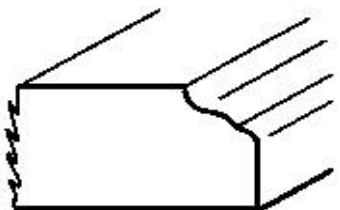

170

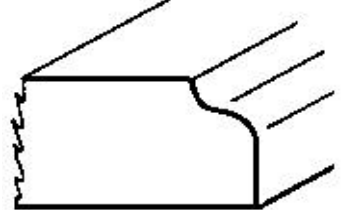

141

FRAMELESS AND FULL OVERLAY EDGE PROFILES

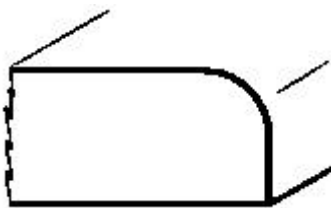

112



114

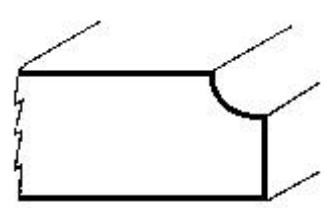

113



115

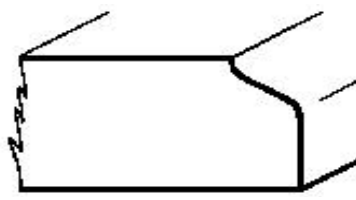

132

FRAMELESS AND FULL OVERLAY APPLICATIONS

If you indicate to us by adding an "E" after the edge profile number, we will hold the tolerances to +0,-1/16" and check every door and drawer front for squareness. We recommend a 3mm (1/8") reveal to allow for normal wood expansion and contraction. Add \$.50 per square foot.

If you are ordering doors for a metric application, please convert your order from millimeters by dividing by 25.4 and rounding to the nearest 1/16".

OPTIONAL *FRAME* PROFILES

Available on **200** and **300** series **WOOD** doors only.

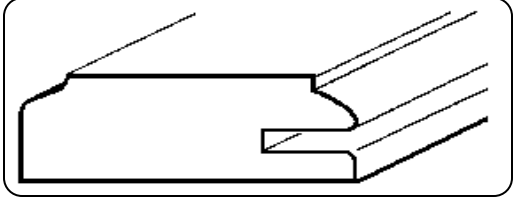

Frame K - 2 1/4" Frame

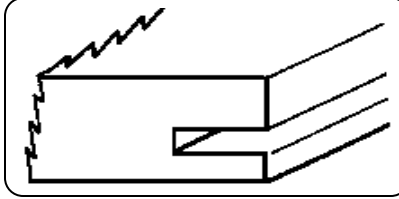

Frame D - 2 1/4" Frame

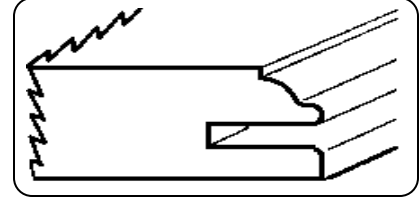

Frame S - 2 1/4" Frame

Other Frame Widths Are Available. Call For Details and Pricing

OPTIONAL *PANEL* PROFILES

Available on **300** and **500** series **WOOD** doors only.

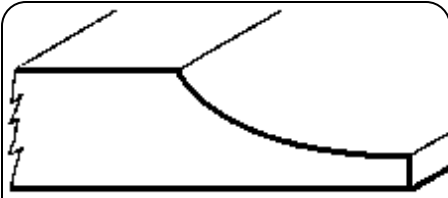

Profile 1

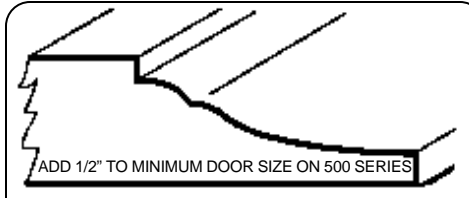

Profile 2

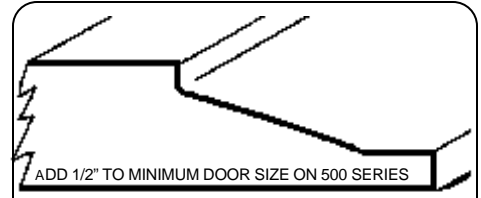

Profile 6

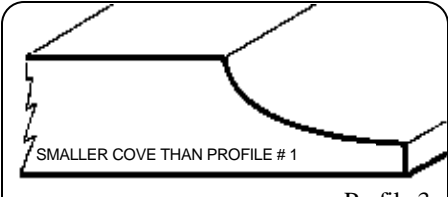

Profile 3

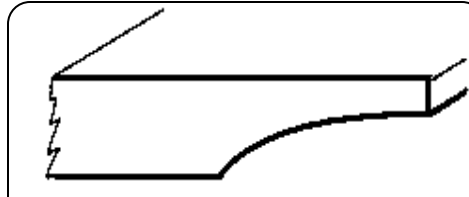

Profile 7

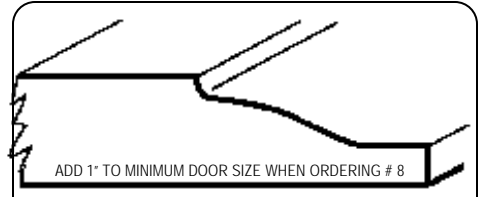

Profile 8

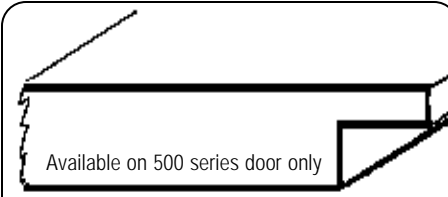

Available on 500 series door only

Profile R



Profile H

PANEL PROFILES FIT 3/8" INSIDE OF DOOR FRAME

Some Panel Profiles will be slightly different than drawings when used with 500 series doors

ALL OPTIONS ON THIS PAGE — NO EXTRA CHARGE

TOUCH-UP ITEMS

Harvest, Royal, Frost Oak,
Frost Maple:

TOUCH-UP KIT - \$ 52.00 ea.

Includes:

Quart Stain \$ 48.00 ea.
Stain Pens \$ 5.50 ea.
Putty Sticks \$ 4.00 ea.
Spray Top Coat \$ 4.50 ea.

1 Putty stick
1 Stain Pen
1 Bottle of Top Coat
1 Bottle of Stain



HINGES

(With screws and door bumpers)

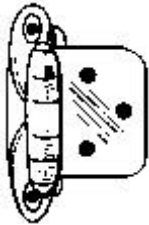

SELF CLOSING PER PAIR

Antique Brass - # 900 \$ 1.50
Bright Brass - # 900B \$ 1.60

BOX OF 100 PAIR - \$ 110.00

Hinge Cup	Mounting Plate		OVERLAY	PER PAIR
		900C	1/2"	\$ 6.00
		900V	VARIABLE (Min. 1 5/8")	\$ 6.00

VENEER APPLICATOR

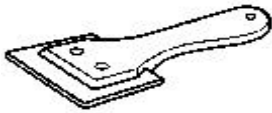

\$ 6.50 ea.

RADIUS CORNERS

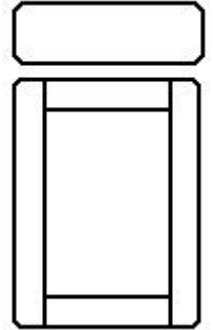
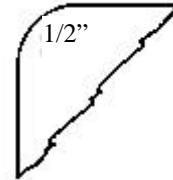
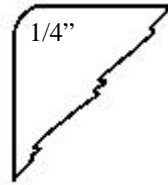

Add \$ 2.50 per door or Drawer Front
Available on 112 and 115 Edge Profiles Only

APPLIED MOULDING

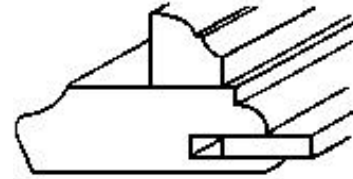

	Standard Size	Large Size	Extra Large Size
DOORS	\$14.00 ea.	\$ 28.00 ea.	\$ 56.00 ea.
		OVER 23" WIDE OR 46" HIGH	OVER 23" WIDE AND 46" HIGH
DRAWER FRONTS	\$14.00 ea.	\$ 28.00 ea.	\$ 56.00 ea.
		OVER 30" WIDE OR 12" HIGH	OVER 30" WIDE AND 12" HIGH

BORING SPECIFICATIONS

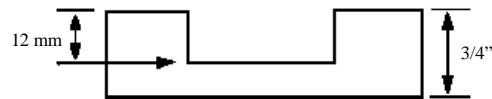
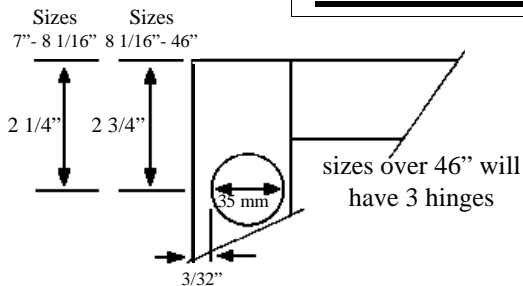

- Must specify Hinge LEFT or RIGHT on arched doors.
- Pairs of doors will be bored 1 Left and 1 Right
- This Boring Pattern may not work with ALL Brands of Hinges!!

MULLION DOORS

NOTE: Mullions of doors of different heights, widths and/or designs may not line up with each other.

* Wood Door Mullions available on 300 Series doors with "K" or "S" profile ONLY. For # 500 Series, # 800 Series, or "D" Frame, Use MULLION INSERTS.

STANDARD MULLION DESIGNS

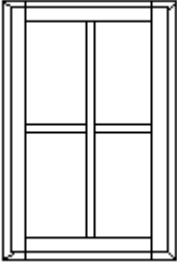

Wood 300- 4 Lite
RTF/MDF 700 - 4 Lite

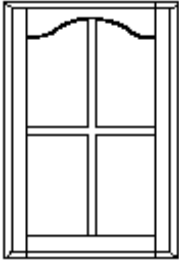

Wood 301- 4 Lite
RTF/MDF 701 - 4 Lite

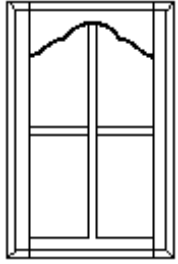

Wood 314 - 4 Lite
RTF/MDF - NA

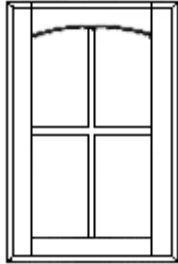

Wood 316 - 4 Lite
RTF/MDF 716- 4 Lite

MULLION INSERTS

ALL WOODS

(Not available in MDF or RTF)

Sold as a separate item. Not installed in Door.

3MI - Use 200 Series Pltwood Sq. Ft.
Material price and add \$ 4.25 per lite.

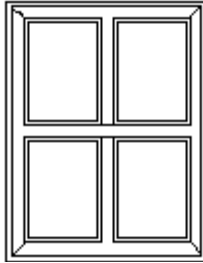

**Use 9" as the Width,
regardless of the
actual width X the
Actual Height to
figure square footage.**

QUARTER CIRCLE ARCH

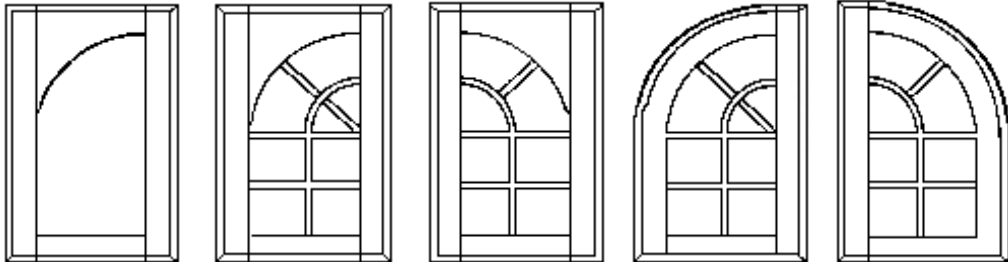

REFACING SUPPLIES & ACCESSORIES

MOLDING

	REAL WOOD UNFINISHED			REAL WOOD PREFINISHED				RTF	
	Oak	Maple Hickory	Cherry	OAK Harvest (Honey) Royal (Toffee) Natural Frost Nordic Caramel Chestnut	MAPLE Royal Natural Frost Wheat Café Cherrystone	CHERRY Harvest (Amber) Royal (Cider) Natural Frost Burgandy	HICKORY Royal (Autumn) Natural	(RTF moulding is made of finger jointed pine wrapped in RTF foil) Antique White Matte White Almond Pear Light Oak Natural Maple Sanibel Maple White Woodgrain	
M1 Scribe	\$ 10.00	\$ 13.00	\$ 18.00	\$ 16.00	\$ 23.00	\$ 24.00	\$ 20.00	\$ 12.00	\$ 15.00
M2 Inside Corner	\$ 14.00	\$ 21.00	\$ 28.00	\$ 20.00	\$ 30.00	\$ 34.00	\$ 27.00	\$ 20.00	\$ 25.00
M3 Outside Corner	\$ 15.00	\$ 28.00	\$ 28.00	\$ 21.00	\$ 37.00	\$ 37.00	\$ 34.00	\$ 17.00	\$ 23.00
M5 Crown	\$ 33.00	\$ 50.00	\$ 69.00	\$ 39.00	\$ 59.00	\$ 75.00	\$ 56.00	\$ 29.00	\$ 38.00
M5E Euro Crown	\$ 43.00	\$ 68.00	\$ 76.00	\$ 52.00	\$ 78.00	\$ 82.00	\$ 74.00	\$ 48.00	\$ 57.00
M7 Screen	\$ 9.00	\$ 13.00	\$ 17.00	\$ 16.00	\$ 22.00	\$ 23.00	\$ 19.00	\$ 15.00	\$ 18.00
MBX Batten	\$ 17.00	\$ 25.00	\$ 34.00	\$ 24.00	\$ 34.00	\$ 40.00	\$ 31.00	\$ 19.00	\$ 24.00
M23 Dentil	\$ 64.00	\$ 75.00	\$ 77.00	\$ 70.00	\$ 81.00	\$ 83.00	\$ 81.00	NA	NA
M24 Rope	\$ 58.00	\$ 66.00	\$ 75.00	\$ 64.00	\$ 72.00	\$ 81.00	\$ 72.00	NA	NA



24" X 96" SELF ADHESIVE SHEETS FOR REFACING CABINETS

SELF ADHESIVE "RTF" FOIL

FOR USE WITH 700 Series "RTF"
and 100 Series LAMINATE DOORS

Pear
Antique White
Matte White
Almond
Light Oak
Natural Maple
Sanibel Maple
White Woodgrain

\$60.00 \$65.00

SELF ADHESIVE HARDWOOD VENEER

FOR USE WITH WOOD DOORS

PREFINISHED

UNFINISHED

OAK	MAPLE	CHERRY	HICKORY
Harvest	Royal	Harvest	
Royal	Natural	Royal	Royal
Frost	Frost		Natural
Natural	Wheat	Natural	
Nordic	Café	Frost	
Caramel	Cherrystone	Burgandy	
Chestnut			

OAK HICKORY
MAPLE CHERRY

\$70.00 \$88.00 \$95.00 \$96.00 \$125.00 \$126.00

NOTE: DUE TO LIMITATIONS IN MANUFACTURING, ADHESIVE WILL NOT EXTEND TO ALL EDGES. TRIMMING MAY BE REQUIRED.

Cut-to-Size 3/16" PLYWOOD (All prices are per square foot)

PART NUMBER	Maximum Width	Maximum Height	UNFINISHED					
			OAK	MAPLE	CHERRY	HICKORY	WHITE PINE KNOTTY PINE	WHITE OAK
488	30"	60"	\$3.20	\$3.90	\$5.80	\$3.80	\$3.80	\$5.60
487	12"	96"	\$3.20	\$3.90	\$5.80	\$3.80	\$3.80	\$5.60
489	48"	96"	\$4.30	\$5.10	\$7.00	\$5.10	\$5.00	\$6.60

PART NUMBER	RTF on MDF		PREFINISHED					
		Pear Light Oak Natural Maple Sanibel Maple White Woodgrain	OAK	MAPLE	CHERRY	HICKORY	WHITE PINE KNOTTY PINE	WHITE OAK
488	\$3.20	\$3.00	Harvest Royal	Cherrystone Wheat Harvest	Burgandy Harvest Royal	Royal	Harvest	Harvest
487	\$3.20	\$3.00	Frost Natural	Sanibel Frost Natural	Harvest Royal	Natural	Natural	Frost Natural
489	\$4.40	\$4.00						

Due to Availability, core may be MDF, Particleboard, or Veneer core.

Note: All accessory items are made to blend with doors and other accessory items. Items may not exactly match in color and texture.

POLICIES AND WARRANTIES

We are proud of our products and stand behind our quality workmanship.

Questions and Price quotes will be promptly responded to via phone, email, or fax.

- We will accept orders by phone, fax, e-mail, and standard mail. Orders received by phone will be carefully repeated back at the time of phone-in. An acknowledgement including item specifications, sizes, quantities, and prices will be promptly faxed for your confirmation. For order to be processed, the Confirmation of your order, as well as a copy of this 'Policies & Warranties' page must be signed and dated, and faxed back to **(716) 832-9294**, or mailed to Custom Kitchen Cabinet & Refacing, 98 Monarch Drive, Amherst, NY 14226.... Two (2) signatures are required in total. From that point, all orders are considered correct and firm.
- We assume no responsibility for incorrect information received by phone, fax or mail. All items are custom made to customer's specifications; Therefore, cancellations of or changes to orders in process are subject to a charge to be determined by the factory at the time of request.
- Once order is in production (usually within 48 hours of receipt), any changes will be at customer's expense.
- Customer will be notified by fax, or email of the approx. shipping date. (generally 7-10 work days for standard door styles, allow extra time during busiest seasons (fall and spring). Allow an additional week for factory staining and finishing, and an additional week for ground delivery. Total normal lead-time is approx. 4 weeks.
- Payment is required before order can be placed in production, since each order is custom made to your specifications. Payment can be made by MASTER CHARGE, VISA, DISCOVER, AMERICAN EXPRESS, CERTIFIED CHECK, or MONEY ORDER.
- All orders will be processed within 24 hours and are non-cancelable and non-refundable after 72 hours, due to the custom nature of the product. Within 72 hours, a 15% or \$100.00 (whichever is greater) order processing fee will apply.
- The entire dollar amount of the order is non-cancelable and non-refundable. If there is any outstanding balance due, it must be paid before shipping. No allowances will be given with the exception of that clearly stated in the Warranty.
- If there is noticable damage to the shipping cartons, you must notify us AND the carrier within 48 hours.
- There will be a service charge of \$25.00 on orders of 10 doors or less.
- Customer must print out these policies and sign the agreement at the bottom stating that he/she has read and understands the policies and warranties setforth and agrees to abide by them. The signed policy page must be faxed to **(716) 832-9294** or mailed to 98 Monarch Drive, Amherst, NY 14226 before doors will be cut to order.

We warrant all standard products for one year from date of shipment against warpage to these tolerances:

- Raised panel doors less than 23" in width and 46" in height are warranted against warpage of more than 1/8".
- Frames and plywood insert panel doors less than 23" in width and 46" in height are warranted against warpage of more than 1/4".
- Doors more than 23" in width and/or 46" in height are not warranted.
- Drawer fronts less than 8" in height and 24" in width are warranted against warpage of more than 1/4".
- Drawer fronts more than 12" in height (across the grain) or 30" in width (with the grain) are not warranted.
- Mitered doors are warranted against joint gaps of 1/128" (.008) or more.
- Slab doors (style 370) are not warranted against warpage.
- Paint Grade or any painted doors are NOT warranted against paint cracks in joints or visible glue lines in panels caused by natural expansion or contraction of raised panels.
- Natural color and grain variations are not warranted, as they are considered normal in real solid wood products. (SELECT grade will have less color variation than the standard grade)
- Warranty covers replacement of door and shipping only. Warranty does not cover installation, removal, or labor of any kind. Nor does this warranty cover any product used or installed in connection with our products. This warranty does not apply to damage resulting from improper handling, alterations or storage.
- All claims, including shortages, must be made within five days of receipt. Any product claimed to be of defective workmanship or material must be returned for inspection at our request. Credit will be issued subject to our inspection. No returns will be accepted without authorization. DO NOT return any merchandise without notifying us first for authorization.
- We will do everything possible to quickly rectify any problems that may arise. We are, as we have been since 1985, dedicated to customer satisfaction.

I, (print name) _____, have read the policies and warranties above and agree to abide by them.

Signed _____ Date _____

Custom Kitchen Cabinet & Refacing
 98 Monarch Drive
 Amherst, NY 14226
 Fax (716) 832-9294 Phone (716) 832-9737

ORDER FORM

ORDER EXACT OVERALL DOOR SIZES

FIRM ORDER

QUOTE ONLY

DATE

NAME
ADDRESS
CITY/STATE/ZIP
PHONE NUMBER
EMAIL ADDRESS

SHIP TO
ADDRESS
ADDRESS (CONT)
CITY/STATE/ZIP

UNFINISHED

PREFINISHED

COLOR: _____

DOORS					DOORS (continued)					DRAWER FRONTS				
WOOD: _____ DESIGN # _____ FRAME PANEL EDGE					WOOD: _____ DESIGN # _____ FRAME PANEL EDGE					WOOD: _____ DESIGN # _____ FRAME PANEL EDGE				
QUANTITY	WIDTH	HEIGHT	OPTIONS		QUANTITY	WIDTH	HEIGHT	OPTIONS		QUANTITY	WIDTH	HEIGHT	OPTIONS	
1					22					1				
2					23					2				
3					24					3				
4					25					4				
5					26					5				
6					27					6				
7					28					7				
8					29					8				
9					30					9				
10					31					10				
11					32					11				
12					33					12				
13					34					13				
14					35					14				
15					36					15				
16					37					OPTIONAL ITEMS (WRITE ADDITIONAL PIECES ON SEPARATE SHEET)				
17					38					1				
18					39					2				
19					40					3				
20					41					4				
21					42					5				